



RWD60

Universal Controller

RWD60

For comfort control in HVAC&R-Systems

- Standalone electronic universal controller with P or PI response
- Operating voltage in accordance to type AC 24 V
- Control application is selectable via Application Number
- Active input scale is selectable
- Limit and direction of the output scale can be freely assigned
- Two universal inputs for Ni 1000, Pt 1000 temperature sensors and DC 0...10 V signals
- Unit can be set as °C, °F, % or no specified unit
- One modulating DC 0...10 V signal outputs, direct or reverse action
- Entering or changing of all data via operating buttons on the controller, no additional tools are needed

Use

The RWD60 universal controllers are intended for Heating, Ventilating, Air-Conditioning and Refrigeration in comfort control plants. It can be mounted in a control cabinet or in the ARG62.21/ARG62.22 housing for ducts, walls and plant rooms installation.

RWD60 is a simplified version of the dual output RWD62, it includes all the main features and functions of RWD62 but with a competitive price. RWD60 is targeted to the large single loop, single output market.

Measurement and control for temperature, relative humidity, absolute humidity, enthalpy, pressure differential, volumetric airflow and indoor air quality. The input scale can be set from –100 to 8,000. The start and end points of output voltage can be any value between DC 0 V to DC 10 V.

Functions summary

- Controller
Stand-alone controller with one DC 0...10 V output for direct acting or reverse acting. Adjustable parameters including proportional band and integral action time.
- Selectable auxiliary function
Universal input X2 for one of the following functions:
 - PI limiter function (absolute and relative)
 - Remote setpoint function
 - Cascade control function
 - Setpoint compensation
 - Winter/summer operation
 - Maximum priority

Type summary

<i>Inputs</i>		<i>Outputs</i>		<i>Type Reference</i>
<i>Universal</i>	<i>Digital</i>	<i>Analog</i>	<i>Digital</i>	
2	0	1	0	RWD60

Accessories

<i>Name</i>	<i>Type</i>
Protective small enclosure for wall mounting	ARG62.21
Protective big enclosure for wall mounting	ARG62.22
Software tool	Not applicable

Equipment combinations

The following Siemens units can be connected to RWD60 universal controller.

<i>Units</i>	<i>Data sheet no.</i>
Sensor with LG-Ni 1000 temperature sensing element	N17... to N19...
Sensor with Pt 1000 temperature sensing element	N1846
Sensor with DC 0...10 V measuring signal	N17... to 19...
Room temperature sensor with setpoint adjuster QAA25 or QAA25/AP	N1721/N1728
Remote setpoint adjusters FZA21.11 and FZA61.11	N19...
Air damper actuators with DC 0...10 V input	N46...
Valve actuators with DC 0...10 V input	N45...
Control valves	N46...
Signal converter SEM 61.4 for current valve control	N51...
Various signal converters	N34...

Other combinations with third-party units are possible, provided the input and output specifications match RWD60.

Software tool

A software tool for controller application selection and parameter adjustment is available for the RWD62. In the RWD60, this functionality is not applicable.

Functions

Controller type

The RWD60 is a stand-alone universal controller, which performs both primary and auxiliary control functions. The respective mode can be defined by entering the corresponding configuration and setting parameters via the operating buttons on the controller.

Main functions

The RWD60 controller can be programmed for only one sequence and only application no 10...19 and 40...49 can be applied:

Sequence: Y1 (reverse or direct acting)

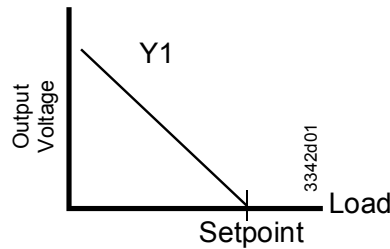

Reverse acting sequence
(application no.: 10...19)

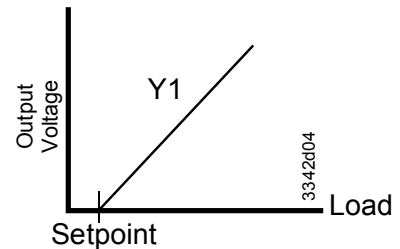

Direct acting sequence
(application no.: 40...49)

Universal input X1

The universal input X1 is used as the primary input for a LG- Ni 1000 temperature sensor, a Pt 1000 temperature sensor or a DC 0...10 V active input.

Universal input X2

The universal input X2 is used as the secondary input for a LG-Ni 1000 temperature sensor, a Pt 1000 temperature sensor, an active/passive remote setpoint transmitter or a DC 0...10 V active input.

Analog outputs

The output Y1 can be configured for either reverse or direct acting. The modulating voltage output controls the devices requiring a DC 0...10 V signal.

Example

Ventilating plant with temperature control

X1 Room temperature
Y1 Heating, reverse or direct action

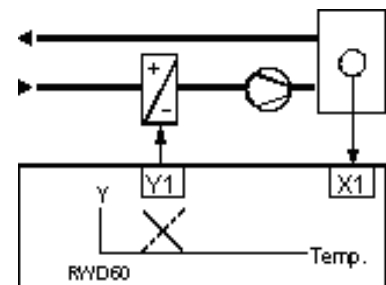

Auxiliary functions

One of the following auxiliary functions can be selected:

- PI limiter function (absolute and relative)
- Remote setpoint function
- Cascade control function
- Setpoint compensation
- Winter/summer operation
- Maximum priority

PI limiter function

The limiter function with PI control enables absolute (or relative) maximum or minimum limitation of the supply air temperature (X2).

When the value drops below or exceeds the limiter setpoint, the limiter function works and takes priority over the main setpoint.

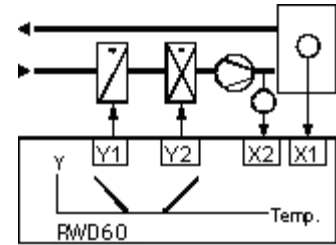

Remote setpoint

A remote setpoint transmitter (FZA21.11, QAA25 or QAA25/AP), which is connected to X2 and configured accordingly, enables setpoint adjustment.

Active measurement from DC 0...10 V corresponds to adjustable range from -100 to 8000

Passive measurement from 0...1000 Ω corresponds to adjustable range from -100 to 8000

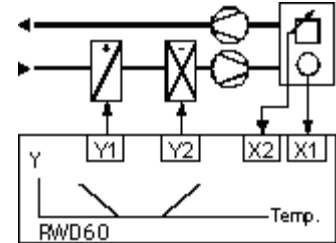

Cascade control

X2 supply air temperature sensor

You can select the **PI/PI room/supply air temperature cascade control**. In this case, the virtual PI room temperature controller determines the setpoint within the limiter setpoints for the PI supply air temperature controller.

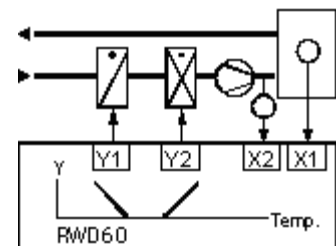

Maximum priority

Maximum priority, cooling

If the value (0...10 V) of the input X2 is greater than the calculated output of the cooling sequence, the output will use the X2 input value as output value. This is active even when the controller is working with the heating sequence.

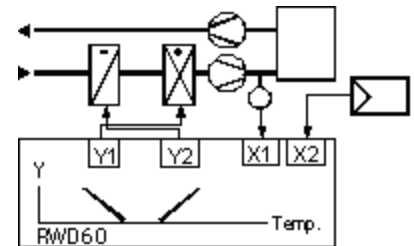

Setpoint compensation

The setpoint of room temperature X1 is influenced by the outside temperature X2. Configuration of the RWD60 defines the influence of X2 on setpoint X1.

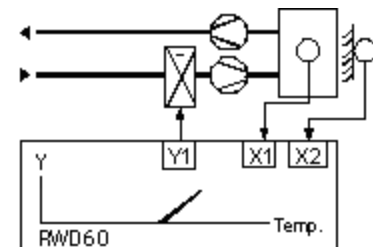

Winter/summer operation

A digital switch or analogue input between terminals X2 and M can be used to implement winter/summer changeover.

Digital changeover

When the contact is closed, summer operation is selected. Reverse acting output (Y1 only) is set to direct action (cooling).

Analog changeover

When the X2 input exceeds the setpoint, summer operation is selected. Reverse acting output (Y1 only) is set to direct action (cooling).

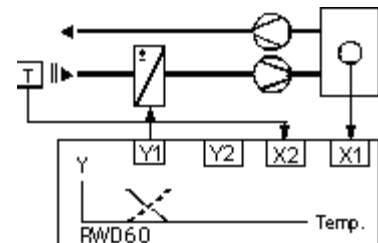

Mechanical design

Housing

The RWD60 universal controller is as per DIN 43 880 Gr. 1 requirements.

Protective housing ARG62.21/ARG62.22

A protective housing is used to protect the controller when mounted outside a control cabinet, such as on ducts, walls and in plant rooms. Furthermore, the protective housing prevents inadvertent contact with voltage supplying parts such as the connecting terminals.

The RWD60 clips into the protective housing.

The cable entries are located at the top and the bottom of the protective housing.

The housing front has an opening for the LCD display and operating buttons.

Terminals

Plug-in screw terminals

Operating and display elements

The RWD60 is operated by the operating buttons on the controller front. Additional tools are not necessary.

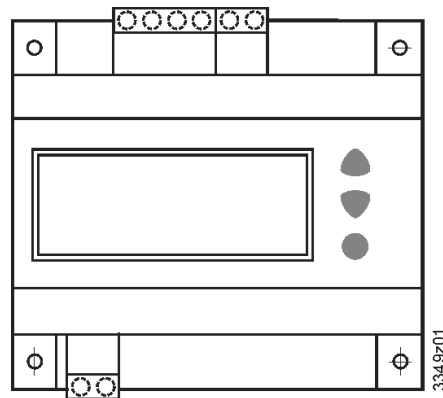

LCD

The LCD shows the following information for normal operation:

- Current operating values (maximum 4 digits)
- Current setpoint
- Application number
- Output voltage value
- Control sequencing diagram
- Auxiliary input value
- Selected auxiliary function

Operating buttons

The controller has three operating buttons for the following functions:



The SELECT button ● is used to enter or save the value adjustment.



The operating buttons ▲ and ▼ are used for viewing and adjusting parameters.

Configuration

To configure the controller, please refer to the instructions supplied with the controller.

Engineering notes

Intended use

Use this controller only for applications as described in the description on the title page (bold print) and the section "Use". Additionally, observe all conditions and restrictions imposed in this section and in "Technical data".



The sections marked with a warning symbol contain technical safety requirements and restrictions. Please observe all of these warnings strictly as they directly relate to the protection of person and equipment.

Installation notes

The RWD60 controllers can be mounted as follows:

- A On a top hat rail (EN60715, 35 × 7.5) at least 120 mm long
- B Wall mounted with 2 screws
- C Front mounted using standard elements, e.g.
 - 1 × top hat rail 150 mm long
 - 2 × hexagonal placeholders 50 mm
 - washers and screws
- D In the ARG62.21/ARG62.22 protective housing

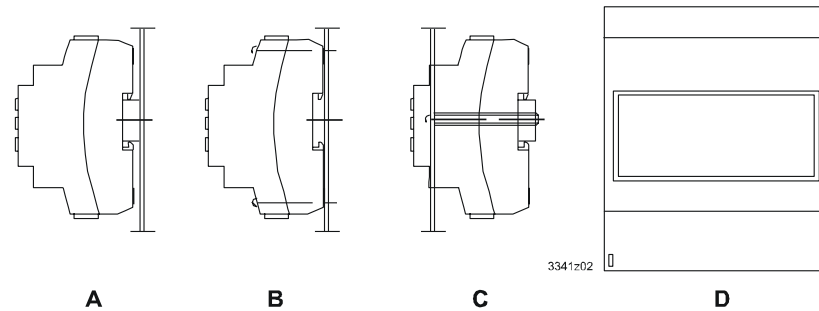

Please observe all current local installation regulations.

Electrical installation

Standard cables can be used for the controller. However, when mounting in an environment greatly exposed to electromagnetic interference (EMI), use only shielded cables.



The RWD60 is designed for AC 24 V operating voltage.

The low voltage must comply with the requirements for safety extra-low voltage (SELV) as per EN 60730.

Use safety insulating transformers with double insulation as per EN 60742; they must be designed for zero downtime.

When using several transformers in one system, the connection terminals G0 must be electrically identified as a common connection for all transformers to prevent short-circuits.

Supplying voltages above AC 24 V to low voltage connections may damage or destroy the controller or any other connected devices. Additionally, connections to voltages exceeding AC 24 V endanger personal safety.

Commissioning notes

A booklet is supplied with the RWD60 controller for commissioning.

Pay attention to the following conditions and restrictions during commissioning:

- The controller must be configured for plant-specific operation using standard application
- Plant specific fine tuning can be performed if required (refer to the commissioning booklet)
- Please make sure the controller and other devices is connected to AC 24 V power supply
- Values and settings entered will be saved automatically on power failure

Technical data

Power Supply 	Operating voltage	AC 24 V ±20%
	Safety extra-low voltage (SELV) as per	EN 60730
	Frequency	50 Hz/60 Hz
	Power consumption	2.5 VA
LCD	Actual and nominal values	4 digits
Resolution (not relate to the controller accuracy)	LG-Ni 1000	0.5 °C
	Pt 1000	0.5 °C
	Active sensor	Depends on the setting range
Environmental conditions	Transport	IEC721-3-2
	Climatic conditions	Class 2K3
	Temperature	-25...70 °C
	Humidity	<95% r.h.
	Mechanical conditions	Class 2M2
	Operation	IEC721-3-3
	Climatic conditions	Class 3K5
Temperature	0...50 °C	
Humidity	<95% r.h.	
IP code	Housing	IP 20 as per EN 60529
	with ARG62.21	IP 30 as per EN 60529
	with ARG62.22	IP 30 as per EN 60529
Norms and standards	EU Conformity (CE)	CE2T3341xx *)
	RCM Conformity	CE2T3341en_c1 *)
Terminals	Screw terminals for cables with	Min. 0.5 mm dia.
		Max. 2 x 1.5 mm ² or 2.5 mm ²
Analog inputs X1, X2		
LG-Ni 1000 Ω at 0 °C	Controller measuring range	-50...150 °C
	Max. cable length for dia. 0.6 mm	Max. 300 m
Pt 1000 Ω at 0 °C	Controller measuring range	-20...180 °C
	Max. cable length for dia. 0.6 mm	Max. 300 m
Analog voltages (for measured variables in °C, % or no unit)	Range	DC 0...10 V corresponds to adjustable range from -100 to 8000 (°C, °F, % or no unit)
	Max. cable length for dia. 0.6 mm	Max. 300 m
Remote setpoint X2	Range	0...1000 Ω corresponds to adjustable range from -100 to 8000 (°C, °F, % or no unit)
	Max. cable length for dia. 0.6 mm	Max. 300 m
Digital input D1		Not applicable
Analog output Y1	Range	DC 0...10 V
	Maximum current	±1 mA
General	Dimensions	130.0 x 106.0 x 56.5 mm (L x W x H)
	Weight without packaging	283 g

*) The documents can be downloaded from <http://siemens.com/bt/download>.

Internal diagram

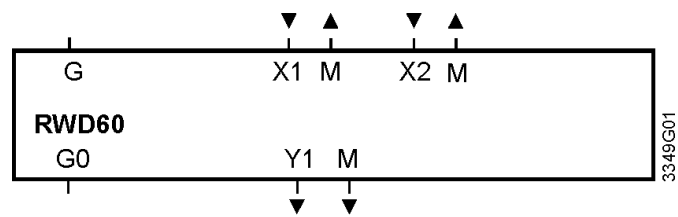

- G, G0 AC 24 V supply (\triangle SELV AC 24 V power supply)
M Ground (G0) for signal inputs, universal inputs and analog outputs
X1 Signal input (main input: LS Ni 1000, Pt 1000 and DC 0...10 V)
X2 Signal input (aux. input: LS Ni 1000, Pt 1000, DC 0 ...10 V and 0...1000 Ω or DC 0...10 V remote setpoint)
Y1 Analog output

Connection diagram

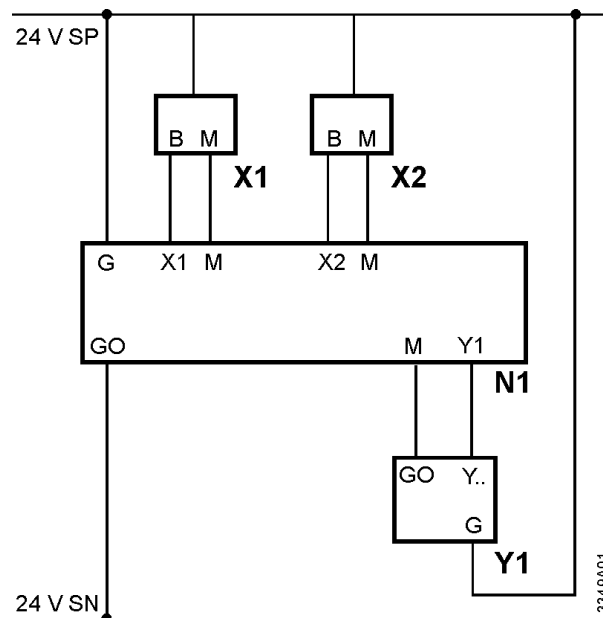

- N1 RWD60 controller
X1 Main input (Termination G appears when X1 is an active sensor)
X2 Auxiliary input or remote setpoint (Termination G appears when X2 is an active sensor)
Y1 Valve actuator or damper actuator

Dimensions (mm)

RWD60

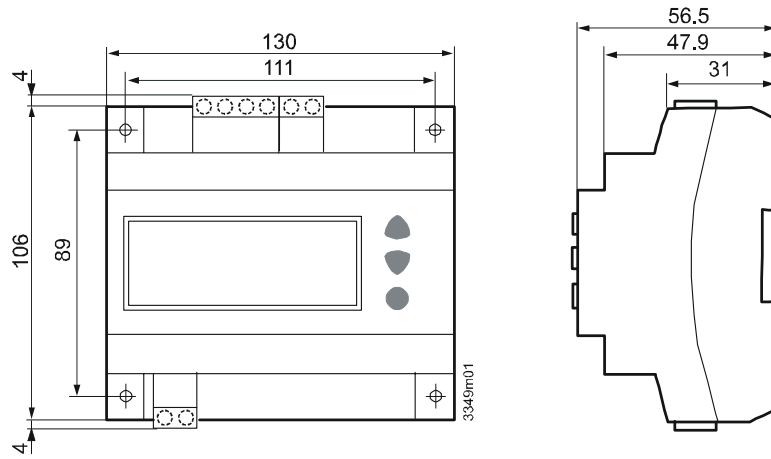

ARG62.21 / ARG62.22

